

Overview

HPE ProLiant ML30 Generation9 (Gen9)

HPE ProLiant ML30 Gen9, delivers a full featured single-socket tower server with the right features at a competitive price, easy to use and maintain for growing small businesses and remote branch offices.

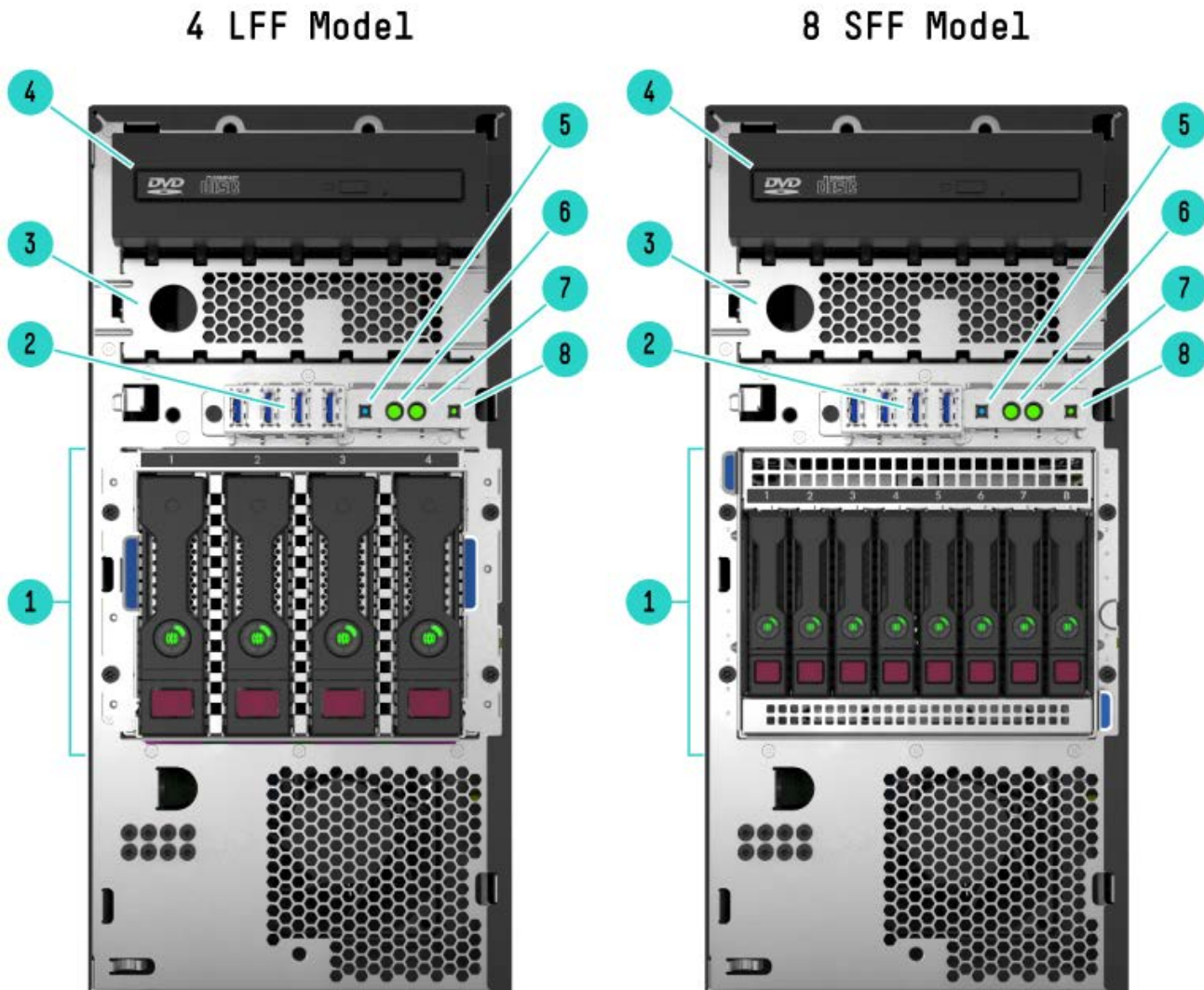

Front View (details for 4LFF and 8SFF)

- | | | | |
|---|---|---|---|
| 1 | Four (4) LFF or Eight (8) SAS/SATA HDD cage | 2 | Four (4) USB 3.0 connectors |
| 3 | Media Drive Blank | 4 | 9.5mm Slim SATA DVD-ROM or DVD RW Optical Drive |
| 5 | Power On/Standby button and system power LED button | 6 | NIC status LED |
| 7 | Health LED | 8 | UID (unit identification) button/LED |

Overview

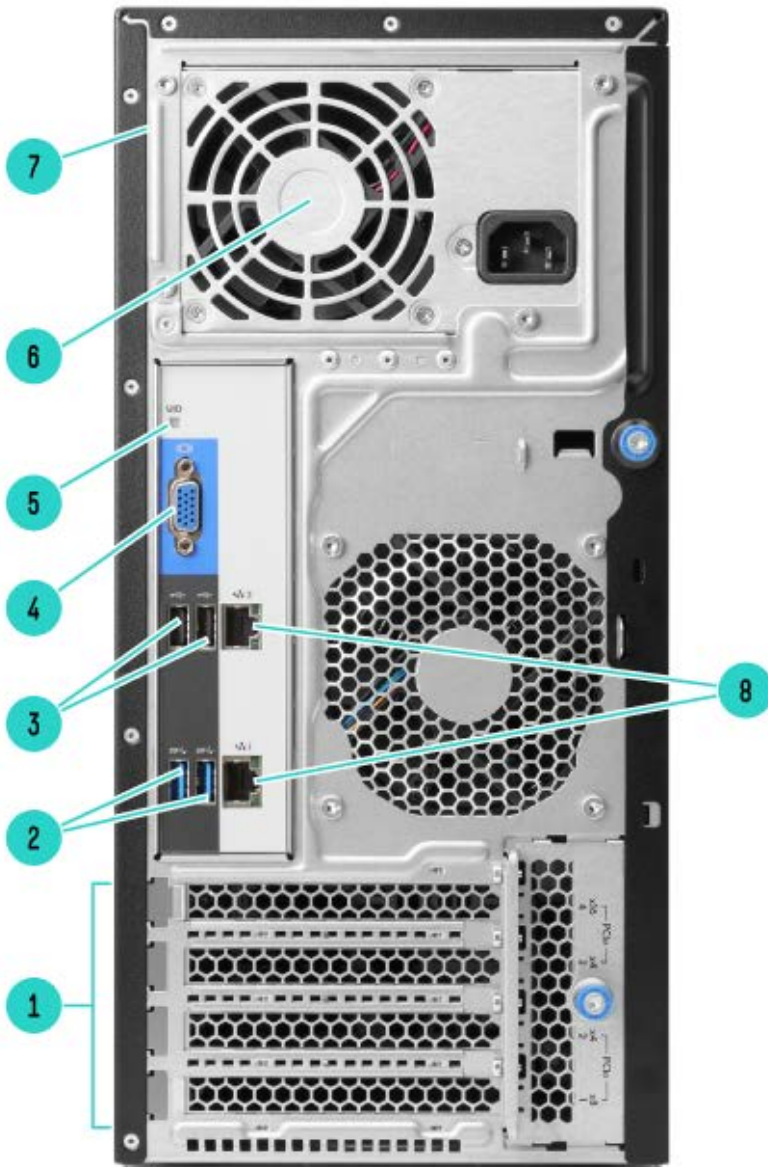

Rear View

- | | | | |
|---|-----------------------|---|---|
| 1 | PCI Slots (Slots 1-4) | 2 | USB 3.0 (2) |
| 3 | USB 2.0 (2) | 4 | Video Connector |
| 5 | UID LED | 6 | Power Supply Power Fan |
| 7 | HPE 350W Power Supply | 8 | NIC 1/shared iLO port (upper), NIC2 (lower) |

Overview

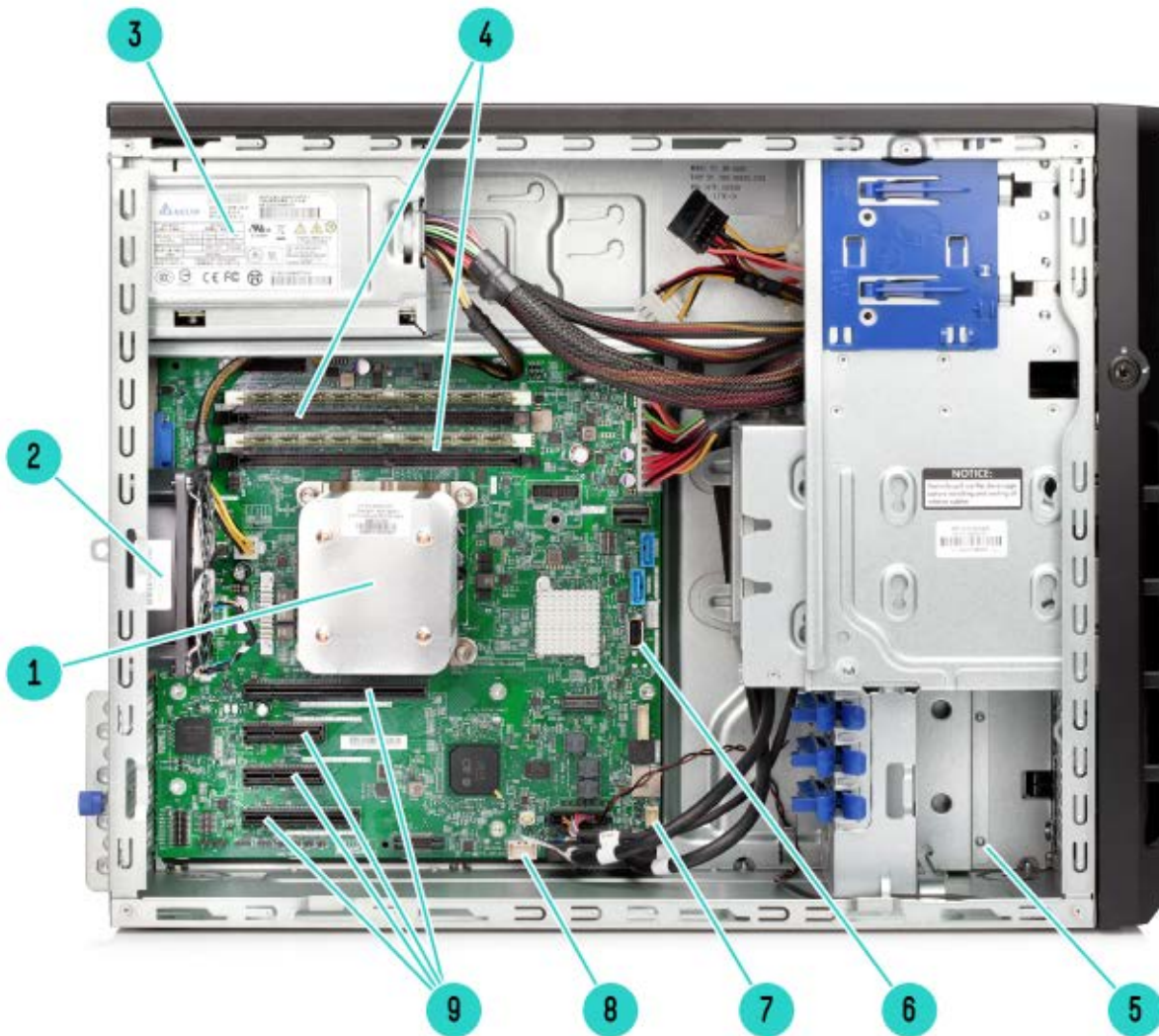

Internal View

- | | | | |
|---|---------------------------------------|---|---|
| 1 | One (1) processor and heatsink | 2 | System Fan |
| 3 | Power Supply | 4 | Four (4) DDR4 DIMM slots |
| 5 | Front PCIe fan (optional) | 6 | Two (2) Internal USB 2.0 connectors (USB Type A, Tape Drive Header) |
| 7 | Gen9 Smart Storage Battery Holder Kit | 8 | MicroSD slot |
| 9 | Four (4) PCIe expansion slots | | |

Standard Features

NOTE: For more information regarding Intel Xeon processors, please see the following <http://www.intel.com/xeon>.

Intel® Xeon® processor E3-1200v5 quad core processor family is designed to deliver the best combination of performance, built-in capabilities, and cost-effectiveness. The product also supports Intel® Pentium® and Intel® Core-i3 dual core processors. Choose one of the following processors based on the model:

Processor	Model	CPU frequency	Cores	L3 Cache	Power	DDR4 Hz
One of the following depending on model	G4400	3.3GHz	2	3MB	54W	2133
	G4500	3.5GHz	2	3MB	51W	2133
	i3-6100	3.7GHz	2	3MB	51W	2133
	i3-6300	3.8GHz	2	4MB	51W	2133
	E3-1220v5	3.0GHz	4	8MB	80W	2133
	E3-1230v5	3.4GHz	4	8MB	80W	2133
	E3-1240v5	3.5GHz	4	8MB	80W	2133
	E3-1270v5	3.6GHz	4	8MB	80W	2133
	E3-1240Lv5	2.1GHz	4	8MB	25W	2133

Cache Memory

One of the following depending on model

8MB (1x8MB) Level 3 cache

NOTE: For Quad-core Intel Xeon processors.

3MB (1 x 3MB) Level 3 Cache

NOTE: For Dual-core Intel Pentium® Core™ i3 processors.

Chipset

Intel® C236 Chipset

NOTE: For more information regarding Intel® chipsets, please see the following URL: <http://www.intel.com/products/server/chipsets/>

On System Management Chipset

HPE iLO (Firmware HPE iLO4 2.0 or later), 4GB NAND

NOTE: 1GB USB user space configurable via UEFI and accessible via iLO. Read and learn more in the [iLO QuickSpecs](#).

Memory

Type:

DDR4 Unbuffered (UDIMM)

DIMM Slots Available

4 4 DIMMs (2 Channels/ 2 DIMMs per channel)

Maximum Capacity 64GB (4 x 16GB UDIMM @2133MHz) (UDIMM)

NOTE: For more information regarding HPE Server Memory visit: <http://www.hp.com/products/memory>.

Memory Protection

ECC

Network Controller

HPE Ethernet 1Gb 2-port NC332i Adapter

Standard Features

Expansion Slots

Expansion Technology	Bus Slots #	Bus Width	Connector Width	Bus Number	Form Factor	Notes
PCIe 3.0	4	x16	x16		Full length/full height	
PCIe 3.0	3	x1	x4		Full length/full height	
PCIe 3.0	2	x1	x4		Full length/full height	
PCIe 3.0	1	x4	x8		Half Length/Full Height	

NOTE: Bus Width indicates the number of physical electrical lanes running to the connector.

Storage Controller Base Models HPE Dynamic Smart Array B140i Controller

One of the following **NOTE: B140i can't mix with any standup internal controller.**

depending on model

Performance Models HPE Dynamic Smart Array B140i Controller

NOTE: B140i can't mix with any standup internal controller.

Internal Storage Devices Optical Drives Optional SATA 9.5mm DVD-ROM Optical Drive
Optional SATA 9.5mm DVD RW Optical Drive

One of the following depending on model

Hard Drives None ship standard

Hard Drive Bays 4 LFF drive bays (non-hot-plug and hot-plug)
8 SFF hot-plug drive bays

NOTE: HPE ProLiant ML30 Series servers offer both SFF and LFF versions in CTO.

NOTE: All Pre-configured Models come populated with some hard drive blanks installed. Should the customer need additional hard drive blanks, they can order more using either P/N 666987-B21: HPE SFF HDD Blank Kit or P/N 666986-B21: HPE LFF HDD Blank Kit.

Maximum Internal Storage

One of the following depending on model

	CAPACITY	CONFIGURATION
Hot Plug LFF SAS	32TB	4 x 8TB
Hot Plug SFF SAS	16TB	8 x 2TB
Hot Plug LFF SATA	32TB	4 x 8TB
Hot Plug SFF SATA	16TB	8 x 2TB
Non-Hot Plug LFF SATA	16TB	4 x 4TB
Hot Plug SFF SATA SSD	960GB	8 x 120GB
Hot Plug LFF SATA SSD	480GB	4 x 120GB

Power Supply HPE 350W ATX-Gen9 Power Supply FIO Kit

One of the following depending on model

HPE 460W Redundant Power Supply

HPE Entry-Level Power Supplies provide lower-cost options for customers trying to balance their need for enterprise class efficiency and reliability while maintaining lowest possible hardware costs. All Entry-Level power supply options have been designed specifically for HPE ProLiant Gen9 Essential Series servers.

The HPE 350W FIO Power Supply is the standard, non-redundant AC power supply option for most HPE ProLiant Gen9 Essential servers. It features Bronze-level (85%) certified power efficiency with a set of features optimized for the Gen9 Essential-series rack and tower servers.

Standard Features

The HPE 460W (Redundant) AC Power Supply can be configured with redundancy enablement kit to support power redundancy in ProLiant ML30 Servers, providing additional protection against power loss. With an 80 Plus Gold power efficiency rating (up to 92%), this power option helps to reduce operating expenses while protecting against trapped power capacity in the data center.

All pre-configured servers ship with a standard 6-foot IEC C-13/C-14 jumper cord (AOK02A). This jumper cord is also included with each standard AC power supply option kit. If a different power cord is required, please check the ProLiant Power Cables web page.

To review the power requirements for your selected system, please use the HPE Power Advisor Tool located at <http://www.hp.com/go/hppoweradvisor>.

Power Specification and Technical Content for supported power supplies can be found at: <http://www.hpe.com/h20195/v2/GetHTML.aspx?docname=c04111541>.

Required Cabling **Server Power Cords**

The ProLiant ML30 server is a tower server that ships standard with a 6 country specific NEMA power cord that allows connection to wall outlets in a home or office. If customers require additional local power cords, they can check the power cord matrix for the appropriate country specific SKU.

System Fans

One of the following depending on model

1P model system fan

Non-redundant

One (1) Non-redundant system fan

Redundant

1P model PCIe fan

Non-redundant

One (1) Non-redundant PCIe fan

Redundant

Interfaces

Video

1 (rear)

Network RJ-45 (Ethernet)

2 (1 shared for HPE Integrated Lights-Out)

Micro SD Slot

1 (internal)

NOTE: The Micro-SD slot is not a hot-pluggable device. Customers should not attempt to plug a Micro-SD card into the Micro-SD slot while the server is powered.

USB 3.0

6 (4 front, 2 rear)

USB 2.0

4 (2 rear, 1 internal standard USB, 1 internal USB header)

Operating Systems and Virtualization Software Support for ProLiant Servers

Microsoft Windows Server

Red Hat Enterprise Linux (RHEL)

SUSE Linux Enterprise Server (SLES)

VMware

NOTE: VMWare availability is dependent on General availability from the vendor. HPE ProLiant ML30 supports VMWare 5.5 U3 and 6.0 U1.

NOTE: For more information on HPE's Certified and Supported ProLiant Servers for OS and Virtualization Software and latest listing of software drivers available for your server, please visit our Support Matrix at: <http://www.hp.com/go/ossupport> and our driver download page: <http://h20566.www2.hp.com/portal/site/hpsc?ac.admitted=1447391526103.125225703.1938120508>.

Standard Features

Upgradeability	Upgradeable to 4 cores NOTE: Total 2 or 4 cores. Up to 4 DIMM slots available for higher memory capacity Up to 8 SFF Hard Drive Bays; or 4 LFF Hard Drive Bays All PCIe3.0 I/O slots for additional communications and storage expansion Redundant Power Supply Optical Drive Bay NOTE: Up to 2.
-----------------------	---

Industry Standard Compliance	ACPI 2.0b Compliant PCIe 3.0 Compliant PXE Support WOL Support Microsoft® Logo certifications USB 2.0 /3.0 Support
-------------------------------------	---

Graphics	Integrated Matrox G200 video standard <ul style="list-style-type: none">• 1280 x 1024 (32 bpp)• 1920 x 1200 (16 bpp) HPE iLO 4 On System Management Memory <ul style="list-style-type: none">• 16 MB Flash• 256 MB DDR 3 with ECC (112 MB after ECC and video)
-----------------	--

HPE Server UEFI/Legacy ROM	Unified Extensible Firmware Interface (UEFI) is an industry standard that provides better manageability and more secured configuration than the legacy ROM while interacting with your server at boot time. HPE ProLiant Gen9 platform defaults to UEFI and can be factory or field configured for Legacy BIOS Boot Mode. NOTE: The UEFI System Utilities function is analogous to the HPE ROM-Based Setup Utility (RBSU) of legacy BIOS. For more information, please visit http://www.hpe.com/servers/uefi.
-----------------------------------	---

UEFI enables numerous new capabilities specific to HPE ProLiant servers such as:

- Secure Boot
- Operating system specific functionality
- Support for > 2.2 TB (using GPT) boot drives
- USB 3.0 Stack
- Embedded UEFI Shell
- Mass Configuration Deployment Tool using RESTful API for iLO 4
- PXE boot support for IPv6 networks
- Boot support for option cards that only support a UEFI option ROM
- Network Stack configurations

NOTE: For UEFI Boot Mode, boot environment and OS image installations should be configured properly to support UEFI.

Standard Features

NOTE: UEFI FIO Setting (758959-B22) can be selected to configure the system in Legacy mode in the factory for your HPE ProLiant Gen9 Server.

Form Factor	Micro ATX Tower (4U) chassis with feet/bezel:
One of the following depending on model	14.5" (36.82cm) Height x 6.89" (17.5cm) Width x 18.71" (47.52cm) Length
	8 SFF Drive Bay Cage: 4.6" (11.74cm) Height x 5.74" (14.57cm) Width x 4.79" (12.15cm) Length
	4 LFF Drive Bay Cage: 4.6" (11.72cm) Height x 5.74" (14.57cm) Width x 6.90" (17.54cm) Length

Embedded Management	HPE Integrated Lights-Out (HPE iLO)	Monitor your servers for ongoing management, service alerting, reporting and remote management with HPE iLO. Not available on ML10 Gen9. Learn more at http://www.hpe.com/info/ilo .
	UEFI	Configure and boot your servers securely with industry standard Unified Extensible Firmware Interface (UEFI). Learn more at http://www.hpe.com/servers/uefi .
	RESTful API	RESTful API for iLO 4 is Redfish 1.0 conformance for simplified server management such as configuration and maintenance tasks based on modern industry standards. Learn more at http://www.hpe.com/info/restfulapi .
	Intelligent Provisioning	Hassle free server and OS provisioning for 1 or few servers with Intelligent Provisioning. Learn more at http://www.hpe.com/servers/intelligentprovisioning .
	Embedded Remote Support	The Hewlett Packard Enterprise embedded remote support, when used with Insight Online direct connect or HPE Insight Remote Support, allows HPE ProLiant servers to transmit hardware events directly to Hewlett Packard Enterprise or a Hewlett Packard Enterprise Authorized Partner for automated phone home support. Learn more at http://www.hpe.com/info/insightonline/explore .

Server utilities	Smart Update	Optimize firmware and driver updates with Smart Update solutions including Smart Update Manager (SUM) and Service Pack for ProLiant (SPP) and smart components. Learn more at http://www.hpe.com/servers/smartupdatemanager .
	HPE Systems Insight Manager (HPE SIM)	HPE SIM allows you to monitor the health of your HPE ProLiant Servers and HPE Integrity Servers, and also provides you with basic support for non-HPE servers. HPE SIM also integrates with Smart Update Manager to provide quick and seamless firmware updates. Learn more at http://www.hpe.com/servers/hpsim .
	Scripting Tool Kit and	Provision 1 to many servers using your own scripts to discover and deploy them with Scripting Tool Kit (STK) for Windows and Linux or Scripting Tools for

Standard Features

Windows PowerShell	Windows PowerShell. Learn more at http://www.hpe.com/servers/proliant/stk or http://www.hpe.com/servers/powershell .
RESTful Interface Tool	RESTful Interface tool is a scripting tool to provision using RESTful API for iLO 4 to discover and deploy servers at scale. Learn more at http://www.hpe.com/info/resttool .
HPE iLO Mobile Application	Enables the ability to access, deploy, and manage your server anytime from anywhere from select smartphones and mobile devices. For additional information please visit: http://www.hpe.com/info/ilo/mobileapp .
HPE Insight Online	HPE Insight Online, available at no additional cost as part of your Hewlett Packard Enterprise warranty, Care Pack or contractual support agreement with Hewlett Packard Enterprise, is a personalized dashboard for simplified tracking of IT operations and support information from anywhere, anytime. Learn more at http://www.hpe.com/info/insightonline/explore .

Security

Power-on password
 Setup password
 Power switch security
 Administrator's password
 TPM 1.2
 TPM 2.0
 UEFI

Warranty

This product is covered by a global limited warranty and supported by HPE Services and a worldwide network of HPE Authorized Channel Partners resellers. Hardware diagnostic support and repair is available for three years from date of purchase. Support for software and initial setup is available for 90 days from date of purchase. Enhancements to warranty services are available through HPE Care Pack services or customized service agreements. Hard drives have either a one year or three year warranty; refer to the specific hard drive QuickSpecs for details.

NOTE: Server Warranty includes 3-Year Parts, 1-Year Labor, 1-Year Onsite support with next business day response. Warranty repairs may be accomplished through the use of Customer Self Repair (CSR) parts. These parts fall into two categories: 1) Mandatory CSR parts are designed for easy replacement. A travel and labor charge will result when customers decline to replace a Mandatory CSR part; 2) Optional CSR parts are also designed for easy replacement but may involve added complexity. Customers may choose to have Hewlett Packard Enterprise replace Optional CSR parts at no charge. Additional information regarding worldwide limited warranty and technical support is available

at: <http://h18004.www1.hp.com/products/servers/platforms/warranty/index.html>

Optional Features

Embedded Management

- iLO Essentials** HPE iLO Essentials is the preferred license for small and medium business that offers full remote server management capabilities for small and medium business via the Integrated Remote Console (IRC), virtual media, and e-mail based alerts. Learn more about HPE iLO Essentials at <http://www.hpe.com/servers/iLO/essentials>.
- iLO Scale-Out** HPE iLO Scale-Out is the preferred license built for web hosting, cloud service providers, and high performance computing data centers, managing massive scale out environments for the DL 100 and 10 series servers, not available for ML servers. This license offers sophisticated scripting tools that provides remote access through Text Console via SSH, Dynamic power capping, Email-based Alerting and proactive notifications. For more information, visit <http://www.hpe.com/servers/iLO/scale-out>.
- iLO Advanced** HPE iLO Advanced licenses offer smart remote functionality without compromise, for all HPE ProLiant servers. The license includes the full integrated remote console, virtual keyboard, video, and mouse (KVM), multi-user collaboration, console record and replay, and GUI-based and scripted virtual media and virtual folders. You can also activate the enhanced security and power management functionality. Learn more about HPE iLO Advanced at <http://www.hpe.com/servers/ioloadvanced>.

Server Management

- HPE Insight Control** HPE Insight Control, lets you deploy, migrate, monitor, remote control, and optimize your IT infrastructure through a single, simple management console. For more information, see <http://www.hpe.com/info/insightcontrol>.

HPC Interconnects **NOTE: High Performance Computing (HPC) interconnect technologies are available for this server under the HPE Cluster Platform product portfolio. These high-speed interconnects are fully supported by Hewlett Packard Enterprise when they are part of these configure to order clusters. Solutions can be defined with a lot of flexibility with the help of configuration tools. Please visit the following URL to configure HPEC Clusters with InfiniBand Interconnects:** <http://www.hp.com/techservers/clusters/ucp/index.html>.

Storage Software

Whether you need to solve a specific data protection, archiving, or storage command and control challenge, or deliver on strategic consolidation, compliance, or continuity initiatives, look no further than Hewlett Packard Enterprise storage software. Our storage software helps you reduce costs, simplify storage infrastructure, protect vital assets and respond faster to business opportunities. Storage software that gets the job done:

- Data Protection and Recovery Software**
 Whether you're a large enterprise or a smaller business, Hewlett Packard Enterprise data protection and recovery software will cost-effectively protect you against disaster and ensure business continuity.
- Data Archive and Migration Software**
 Hewlett Packard Enterprise storage software enables you to comply with data retention and retrieval requirements, improve application performance, and reduce costs by efficiently migrating infrequently accessed or less valuable data to lower cost storage.

Optional Features

- **Storage Resource Management Software (SRM)**
Hewlett Packard Enterprise storage resource management software reduces operational costs and provides the command and control foundation you need to efficiently manage and visualize your physical and virtual environments.
- **Data Replication Software**
Hewlett Packard Enterprise offers array-based and host-based replication software for use in disaster recovery, testing, application development and reporting.
- **Storage Device Management Software**
Maximize your investment in Hewlett Packard Enterprise storage and networking with software that enables hardware-specific configuration, performance tuning and connectivity management.
- **HPE StoreVirtual VSA**
With HPE StoreVirtual VSA you can use the power of virtualization to create a virtual array within your host server. Manage it as a single pool of shared storage capacity, and scale it to match your evolving needs. HPE ProLiant Gen9 servers include a 3-year limited license for HPE StoreVirtual VSA software with 1TB of capacity at no extra cost. Simply select to install HPE StoreVirtual VSA software during server setup within Intelligent Provisioning. More information, instructional videos, and free console management software are available at <http://www.hp.com/go/vsa1TB>.

NOTE: For more information about Storage Software including QuickSpecs, please see: <http://www.hp.com/go/storage/software>.

One Config Simple (SCE) SCE is a guided self-service tool to help sales and non-technical people provide customers with initial configurations in 3 to 5 minutes. You may then send the configuration on for configuration help, or use in your existing ordering processes. If you require "custom" rack configuration or configuration for products not available in SCE, please contact Hewlett Packard Enterprise Customer Business Center or an Authorized Partner for assistance. <https://h22174.www2.hp.com/SimplifiedConfig/Index>.

Service and Support

HPE Support Services

HPE Technology Services delivers confidence, reduces risk and helps customers realize agility and stability. Connect to Hewlett Packard Enterprise to help prevent problems and solve issues faster. HPE Support Services enable you to choose the right service level, length of coverage and response time as you purchase your new server, giving you full entitlement to the support for need for your IT and business.

Connect your devices

Unlock all of the benefits of your technology investment by connecting your products to Hewlett Packard Enterprise. Achieve up to 77%¹ reduction in down time, near 100%² diagnostic accuracy and a single consolidated view of your environment. By connecting, you will receive 24x7 monitoring, pre-failure alerts, automatic call logging, and automatic parts dispatch. HPE Proactive Care Service and HPE Datacenter Care Service customers will also benefit from proactive activities to help prevent issues and increase optimization. All of these benefits are already available to you with your server storage and networking products, securely connected to Hewlett Packard Enterprise support.

1- IDC 2 - HP CSC reports 2014 - 2015

Recommended Support

Basic: HPE Foundation Care NBD, three-year Support Service

HPE Foundation Care Next Business Day connects you to Hewlett Packard Enterprise during business hours for assistance on resolving issues – This service features need based next business day hardware onsite response and software call back within two hours. In addition, Collaborative software support and provides troubleshooting assistance on industry leading software running on your HPE server. Simplify your support experience and make Hewlett Packard Enterprise your first call to help resolve hardware or software problems.

<http://www.hpe.com/h20195/V2/GetDocument.aspx?docname=4AA4-8876ENW&cc=us&lc=en>

Standard: HPE Foundation Care 24x7, three-year Support Service

HPE Foundation Care 24x7 gives you access to Hewlett Packard Enterprise 24 hours a day, seven days a week for assistance on resolving issues. This service includes need based Hardware onsite response within four hours. In addition, collaborative software support is included in this service that provides troubleshooting assistance on industry leading software running on your HPE server. Simplify your support experience and make Hewlett Packard Enterprise your first call to help resolve hardware or software problems.

<http://www.hpe.com/h20195/V2/GetDocument.aspx?docname=4AA4-8876ENW&cc=us&lc=en>

Optimized: HPE Proactive Care* with 24x7 coverage, three year Support Service

HPE Proactive Care gives customers an enhanced call experience. When your products are connected to Hewlett Packard Enterprise, Proactive Care helps prevent problems and maintains IT stability by utilizing personalized proactive reports with recommendations and advice. This service combines three years proactive reporting and advice with our 24x7 coverage, four hour hardware response time when there is a problem. This service also includes collaborative software support for Independent Software Vendors (ISVs), (Red Hat, VMWare, Microsoft, etc.) running on your HPE servers.

Parts and Materials

Hewlett Packard Enterprise will provide Hewlett Packard Enterprise-supported replacement parts and materials necessary to maintain the covered hardware product in operating condition, including parts and materials for available and recommended engineering improvements.

Parts and components that have reached their maximum supported lifetime and/or the maximum usage limitations as set forth in the manufacturer's operating manual, product QuickSpecs, or the technical product data sheet will not be provided, repaired, or replaced as part of these services.

The defective media retention service feature option applies only to Disk or eligible SSD/Flash Drives replaced by Hewlett Packard Enterprise due to malfunction.

Service and Support

Related Services **HPE Server Hardware Installation**

Provides for the basic hardware installation of Hewlett Packard Enterprise branded servers, storage devices and networking options to assist you in bringing your new hardware into operation in a timely and professional manner.

<http://h20195.www2.hp.com/V2/GetPDF.aspx/5981-9356EN.pdf>

HPE Installation and Startup Service

Provides for the installation and startup of Hewlett Packard Enterprise technology including BladeSystems, C-Class enclosure, HPE ProLiant c-Class and Integrity server blades, storage blades, SAN switch blades, HPE Virtual Connect modules (Ethernet and Fibre Channel), Ethernet network interconnects, and InfiniBand, as well as the installation of one supported operating system type (Windows® or Linux).

HPE Technology Services Support Credits

Offer flexible services and technical skills to meet your changing IT demands. With a menu of service that is tailored to suit your needs, you get additional resources and specialist skills to help you maintain peak performance of your IT. Offered as annual credits, you can plan your budgets while proactively responding to your dynamic business.

HPE Education Services

Keep your IT staff trained making sure they have the right skills to deliver on your business outcomes. Book on a class today and learn how to get the most from your technology investment. <http://www.hpe.com/ww/learn>

HPE Support Center

The HPE Support Center is a personalized online support portal with access to information, tools and experts to support Hewlett Packard Enterprise business products. Submit support cases online, chat with Hewlett Packard Enterprise experts, access support resources or collaborate with peers.

Learn more <http://www.hpe.com/support/hpesc>

The Hewlett Packard Enterprise Support Center Mobile App* allows you to resolve issues yourself or quickly connect to an agent for live support. Now, you can get access to personalized IT support anywhere, anytime. HPE Insight Remote Support and HPE Support Center are available at no additional cost with a Hewlett Packard Enterprise warranty, HPE Support Service or Hewlett Packard Enterprise contractual support agreement.

*HPE Support Center Mobile App is subject to local availability.

For more information: <http://www.hpe.com/services>

Pre-configured Models

1. Pre-configured models ship with the configurations below. Options can be selected from the Core or Additional options section of this QuickSpecs.
2. Not all models are available in all regions. Check with your local country Hewlett Packard Enterprise offices for availability.

	Base Models	Performance Models
[SKU Number]	824379-xx1	830893-xx1
Model Name	HPE ProLiant ML30 Gen9 E3-1220v5 1P 4GB-U B140i 4LFF SATA 350W PS Base Server	HPE ProLiant ML30 Gen9 E3-1240v5 1P 8GB-U B140i 4LFF SATA 460W RPS Perf Server
Processor	Intel® Xeon® E3-1220v5	Intel® Xeon® E3-1240v5
Number of Processors	One	
Memory	4GB (1x4GB UDIMMs, 2133 MHz)	8GB (1x8GB UDIMMs, 2133 MHz)
Network Controller	Broadcom 5720 Dual-port 1GbE	
Storage Controller	HPE Dynamic Smart Array B140i	
Hard Drive	None ship standard; includes 2 LFF hard drive blanks	
Internal Storage	4 LFF HDD Bays (Hot Plug)	
Optical Drive Bay	1; (Optional: DVD-ROM, DVD-RW)	
Optical Drive	None	
PCI-Express Slots	4 PCIe 3.0 slots	
Power Supply	(1) 350W ATX Power Supply	(1) 460W Redundant Power Supply
Fans	1 non hot plug, non-redundant	
Management	iLO Management (standard), Intelligent Provisioning (standard), iLO Essentials (optional), iLO Scale-out (optional only for DL), iLO Advanced (optional)	
Form Factor	Tower (4U)	
Warranty	Server Warranty includes 3-Year Parts, 1-Year Labor, 1-Year Onsite support with next business day response.	
	NOTE: APJ Server Warranty includes 3-Year Parts, 3-Year Labor, 3-Year Onsite support with next business day response.	

Country Code Key	xx1 = B21	Worldwide
	xx1 = 001	US
	xx1 = 421	EU
	xx1 = 031	UK
	xx1 = 371	AP
	xx1 = 291	Japan
	xx1 = AA1	PRC

NOTE: Not all models are available in all regions. Check with your local country Hewlett Packard Enterprise offices for availability.

Configuration Information - Factory Integrated Models

This section lists some of the steps required to configure a Factory Integrated Model. To ensure only valid configurations are ordered, Hewlett Packard Enterprise recommends the use of an HPE approved configurator. Contact your local sales representative for information on configurable product offerings and requirements.

1. Factory Integrated Models must start with a CTO Server.
2. FIO indicates that this option is only available as a factory installable option.
3. All Factory Integrated Models will be populated with sufficient hard drive blanks based on the number of initial hard drives ordered with the server.
4. Some options may not be integrated at the factory. Contact your local sales representative for additional information.

Step 1: Base Configuration (choose one of the following configurable models)

[Chassis]	HPE ProLiant ML30 Gen9 Non-hot Plug 4LFF Configure-to-order Server	HPE ProLiant ML30 Gen9 Hot Plug 4LFF Configure-to- order Server	HPE ProLiant ML30 Gen9 Hot Plug 8SFF Configure-to- order Server
SKU Number	823401-B21	823402-B21	823403-B21
Processor	1	1	1
DIMM Slots	4 DIMM slots for UDIMM DDR4 Memory		
Storage Controller	HPE Dynamic Smart Array B140i		
PCIe	4 PCIe 3.0 slots		
Drive Cage	4LFF Non Hot Plug	4LFF Hot Plug	8SFF Hot Plug
Network Controller	Broadcom 5720 Dual-port 1GbE		
Fans	1 non hot plug, non-redundant		
Management	iLO Management (standard), Intelligent Provisioning (standard)		
USB	4 front, 4 rear, 2 internal		

Step 2: Choose Required Options (only one of the following from each list unless otherwise noted)

HPE Processors ML30 Select one processor from Core options-Processor section below

- Select one xxxxxx-L21.
- Only one processor supported.
- DDR4 speed is the maximum memory speed of the processor. Actual memory speed may depend on the quantity and type of DIMMs installed.

For the Intel® C236 Chipset E3-1200 Series, the letter preceding the model number indicates the Product Line (E3, E5, E7); 1200x v#, 1 is the number of CPU, 2 is socket type/segment designation, 00 = Processor SKU, x = L for low power SKUs and v# (not yet designated) is the version number.

HPE Memory Select one or more memory from Core options-Memory section below,

- HPE memory from previous generation servers are not qualified or warranted with this HPE ProLiant Server.
- HPE Standard Memory (UDIMM) is required to realize the memory performance improvements and enhanced functionality listed in this document for this HPE ProLiant Server.
- With one processor installed, four DIMMs slots are available.

Configuration Information - Factory Integrated Models

- For more information on ProLiant Energy Efficient Features, see: <http://www.hp.com/go/proliant-energy-efficient>.
- Depending on the memory configuration and processor model, the memory speed would run at 2133MHz. Please see Memory Population Table or the Online Memory Configuration Tool at: <http://www.hp.com/go/ddr4config>.

HPE Power Supplies

Select one or more power supplies from Core Options-Power Supplies section below:

- Prior to selecting a power supply option, it is highly recommended that you review your server configuration in the HPE Power Advisor tool to determine the right size power supply for your server configuration. The HPE Power Advisor is located at: <http://www.hp.com/go/hppoweradvisor>.
- Mixing of power supplies in the same server is not supported. All power supplies must be of the same input voltage, output rating, and efficiency rating. If non-matching power supplies are installed, you may receive an error message and/or experience operational issues with your server.

Step 3: Choose Additional Factory Integratable Options

HPE Networking Select a standup NIC adapter from Core options-Networking section below,

- Please see the QuickSpecs for Technical Specifications and additional information: <http://www.hp.com/go/ProLiantNICs>.
- These options are upgradeable and can be changed from the original configuration after the server is shipped.
- For 10Gb adapters, a minimum of two Gigabytes (2 GB) of server memory is required per each adapter.

HPE Drives

Select one or more drives from Core options-HPE Drives section below:

- The components of a storage subsystem (e.g. the drive, the HBA/controller, firmware, and the server backplane) should operate at the same data transfer rate or the system bandwidth will be negotiated down to an acceptable level for all components.
- Hard drives have either a one year or three year warranty; refer to the specific hard drive QuickSpecs for details.
- The HPE ProLiant Gen9 Smart Storage solutions are equipped with re-designed Small Form Factor (SFF 2.5 in) and Large Form Factor (LFF 3.5 in) hot plug carriers for HPE Qualified Hard Drives and Solid State Drives. These new carriers provide status and activity indicators as well as caution indicators for "Do Not Remove".

HPE Graphics Options

Select one or more graphics adapter from Additional options section below.

- Please see the HPE Power Advisor for estimated power consumption of your individual system configuration prior to installing GPUs. The HPE Power Advisor is located at: <http://www.hp.com/go/hppoweradvisor>.
- This section may contain FIO options, please see HPE Computation & Graphics Accelerators section below.

HPE Unique Options

Select one or more Unique options from Core options section below.

Configuration Information - Factory Integrated Models

- This section may contain FIO options, please see the Unique options section below.
- FIO indicates that this option is only available as a factory installable option.

HPE Cooling Options

Select one or more Fan Kits from Core options section below.

- This section may contain FIO options, please see HPE Cooling Options section below.
- FIO indicates that this option is only available as a factory installable option.

HPE Storage Controllers

Select one or more Storage options from Additional options section below.

- The embedded B140i controller will operate in UEFI only mode. For legacy support an additional controller will be needed, and for CTO orders please also select the Legacy mode settings part, 758959-B22
- This section may contain FIO options, please see HPE Storage Controllers section below.
- FIO indicates that this option is only available as a factory installable option.

Core Options

NOTE: Some options may not be integrated at the factory. To ensure only valid configurations are ordered, Hewlett Packard Enterprise recommends the use of an HPE approved configurator. Contact your local sales representative for additional information.

HPE Unique Options	HPE ML30 Gen9 Slim Optical Disk Drive Enablement Kit	820288-B21
	HPE ML30 Gen9 Front PCI Redundant Fan Kit	820290-B21
	NOTE: Required for any PCI-E card.	
	HPE ML30 Gen9 350W E-star 2.0 Power Supply Kit	822384-B21
	HPE ML30 Gen9 4U Redundant Power Supply Enablement Kit	822607-B21
	HPE ML30 Gen9 4 Large Form Factor Hot Plug Hard Drive Cage Kit	822608-B21
	NOTE: The LFF Kit is a backplane kit designed for going from NHP LFF to hot-plug LFF.	
	HPE ML30 Gen9 8 Small Form Factor Hot Plug Hard Drive Cage Kit	822756-B21
NOTE: The SFF Kit is the cage plus backplane and designed to convert from any LFF configuration to SFF.		
HP Tower to Rack Conversion Tray Universal Kit	417705-B21	
NOTE: Require HPE ML30 Gen9 Front PCI Fan Kit (820290-B21).		
NOTE: ML30 Gen9 is not designed for a data center rack application environment, the Tower to Rack setting can be located in the office environment up to 35C ambient.		

HPE Processors	Entry Processors	
	HPE ML30 Gen9 Intel® Pentium® G4400 (3.3GHz/2-core/3MB/54W) FIO Processor Kit	820295-L21
	HPE ML30 Gen9 Intel® Pentium® G4500 (3.5GHz/2-core/3MB/51W) FIO Processor Kit	823389-L21
	HPE ML30 Gen9 Intel® Core™ i3-6300 (3.8GHz/2-core/4MB/51W) FIO Processor Kit	823379-L21
	HPE ML30 Gen9 Intel® Core™ i3-6100 (3.7GHz/2-core/3MB/51W) FIO Processor Kit	837095-L21
	Base Processors	
	HPE ML30 Gen9 Intel® Xeon® E3-1220v5 (3.0GHz/4-core/8MB/80W) FIO Processor Kit	820293-L21
	HPE ML30 Gen9 Intel® Xeon® E3-1230v5 (3.4GHz/4-core/8MB/80W) FIO Processor Kit	823371-L21
	Performance Processors	
	HPE ML30 Gen9 Intel® Xeon® E3-1240Lv5 (2.1GHz/4-core/8MB/25W) FIO Processor Kit	820299-L21
	HPE ML30 Gen9 Intel® Xeon® E3-1240v5 (3.5GHz/4-core/8MB/80W) FIO Processor Kit	823373-L21
	HPE ML30 Gen9 Intel® Xeon® E3-1270v5 (3.6GHz/4-core/8MB/80W) FIO Processor Kit	823375-L21

HPE Memory	Unbuffered DIMMs (UDIMMs)	
	HPE 4GB (1x4GB) Single Rank x8 DDR4-2133 CAS-15-15-15 Unbuffered Standard Memory Kit	805667-B21

Core Options

HPE 8GB (1x8GB) Dual Rank x8 DDR4-2133 CAS-15-15-15 Unbuffered Standard Memory Kit	805669-B21
HPE 16GB (1x16GB) Dual Rank x8 DDR4-2133 CAS-15-15-15 Unbuffered Standard Memory Kit	805671-B21
HPE 8GB (1x8GB) Single Rank x8 DDR4-2133 CAS-15-15-15 Unbuffered Standard Memory Kit	819880-B21

HPE Optical Drives HP 9.5mm SATA DVD-ROM JackBlack Gen9 Optical Drive	726536-B21
HP 9.5mm SATA DVD-RW JackBlack G9 Optical Drive	726537-B21
HPE ML30 Gen9 Slim Optical Disk Drive Enablement Kit	820288-B21
NOTE: Max=1 if selected together with 460W Hot Plug Power Supply.	

HPE Drives

NOTE: The components of a storage subsystem (e.g. the drive, the HBA/controller, firmware, and the server backplane) should operate at the same data transfer rate or the system bandwidth will be negotiated down to an acceptable level for all components.

NOTE: Hard drives have either a one year or three year warranty; refer to the specific hard drive QuickSpecs for details.

SAS Hot Plug SFF (2.5-inch) Enterprise (ENT) Drives

HP 1.2TB 6G SAS 10K rpm SFF (2.5-inch) SC Dual Port Enterprise 3yr Warranty Hard Drive	718162-B21
HP 900GB 6G SAS 10K rpm SFF (2.5-inch) SC Enterprise 3yr Warranty Hard Drive	652589-B21
HP 600GB 12G SAS 15K rpm SFF (2.5-inch) SC Enterprise 3yr Warranty Hard Drive	759212-B21
HP 600GB 6G SAS 10K rpm SFF (2.5-inch) SC Enterprise 3yr Warranty Hard Drive	652583-B21
HP 450GB 12G SAS 15K rpm SFF (2.5-inch) SC Enterprise 3yr Warranty Hard Drive	759210-B21
HP 450GB 6G SAS 10K rpm SFF (2.5-inch) SC Enterprise 3yr Warranty Hard Drive	652572-B21
HP 300GB 12G SAS 15K rpm SFF (2.5-inch) SC Enterprise 3yr Warranty Hard Drive	759208-B21
HP 300GB 6G SAS 10K rpm SFF (2.5-inch) SC Enterprise 3yr Warranty Hard Drive	652564-B21
HP 146GB 6G SAS 15K rpm SFF (2.5-inch) SC Enterprise 3yr Warranty Hard Drive	652605-B21
HP 600GB 12G SAS 10K rpm SFF (2.5-inch) SC Enterprise 3yr Warranty Hard Drive	781516-B21
HP 1.2TB 12G SAS 10K rpm SFF (2.5-inch) SC Enterprise 3yr Warranty Hard Drive	781518-B21
HP 1.8TB 12G SAS 10K rpm SFF (2.5-inch) SC Enterprise 512e 3yr Warranty Hard Drive	791034-B21
HP 3TB 6G SATA 7.2K rpm LFF (3.5-inch) Non-hot plug Midline 1yr Warranty Hard Drive	628065-B21
HP 2TB 6G SATA 7.2K rpm LFF (3.5-inch) Non-hot plug Midline 1yr Warranty Hard Drive	659339-B21
NOTE: User may select any combination of SAS or SATA Hard Drives. SAS drives require the selection of a SAS controller. See card lists in Controllers section.	
If B140i is the primary controller, user can only select SATA drives.	
HP 300GB 12G SAS 10K rpm SFF (2.5-inch) SC Enterprise 3yr Warranty Hard Drive	785067-B21
HP 900GB 12G SAS 10K rpm SFF (2.5-inch) SC Enterprise 3yr Warranty Hard Drive	785069-B21

Core Options

HP 1TB 6G SATA 7.2K rpm LFF (3.5in) Non-hot Plug Standard 1yr Warranty Hard Drive	801882-B21
HP 2TB 6G SATA 7.2K rpm LFF (3.5in) Non-hot Plug Standard 1yr Warranty Hard Drive	801884-B21
HP 3TB 6G SATA 7.2K rpm LFF (3.5in) Non-hot Plug Standard 1yr Warranty Hard Drive	801886-B21
HP 4TB 6G SATA 7.2K rpm LFF (3.5in) Non-hot Plug Standard 1yr Warranty Hard Drive	801888-B21
HP 1TB 6G SATA 7.2K rpm LFF (3.5-inch) Non-hot plug Midline 1yr Warranty Hard Drive	659337-B21
HP 500GB 6G SATA 7.2K rpm LFF (3.5-inch) Non-hot plug Midline 1yr Warranty Hard Drive	659341-B21

SAS Hot Plug SFF (2.5-inch) Midline (MDL) Drives

HP 1TB 6G SAS 7.2K rpm SFF (2.5-inch) SC Midline 1yr Warranty Hard Drive	652749-B21
HP 500GB 6G SAS 7.2K rpm SFF (2.5-inch) SC Midline 1yr Warranty Hard Drive	652745-B21
HPE 1TB 12G SAS 7.2K rpm SFF (2.5in) SC Midline 1yr Warranty Hard Drive	832514-B21
HP 1TB 12G SAS 7.2K rpm SFF (2.5-inch) SC 512e 1yr Warranty Hard Drive	765464-B21
HP 2TB 12G SAS 7.2K rpm SFF (2.5-inch) SC 512e 1yr Warranty Hard Drive	765466-B21

NOTE: User may select any combination of SAS or SATA Hard Drives. SAS drives require the selection of a SAS controller. See card lists in Controllers section.

If B140i is the primary controller, user can only select SATA drives.

SAS Hot Plug LFF (3.5-inch) Enterprise (ENT) Drives

HP 450GB 12G SAS 15K rpm LFF (3.5-inch) SC Converter Enterprise 3yr Warranty Hard Drive	737394-B21
HP 300GB 12G SAS 15K rpm LFF (3.5-inch) SC Converter Enterprise 3yr Warranty Hard Drive	737261-B21
HP 600GB 12G SAS 15K rpm LFF (3.5-inch) SC Converter Enterprise 3yr Warranty Hard Drive	765424-B21
HP 6TB 12G SAS 7.2K rpm LFF (3.5-inch) SC 512e Helium 1yr Warranty Hard Drive	793699-B21
HP 8TB 12G SAS 7.2K rpm LFF (3.5-inch) SC 512e Helium 1yr Warranty Hard Drive	793703-B21

NOTE: User may select any combination of SAS or SATA Hard Drives. SAS drives require the selection of a SAS controller. See card lists in Controllers section.

If B140i is the primary controller, user can only select SATA drives.

SAS Hot Plug LFF (3.5-inch) Midline (MDL) Drives

HP 6TB 6G SAS 7.2K rpm LFF (3.5-inch) SC Midline 1yr Warranty Hard Drive	761477-B21
HP 4TB 6G SAS 7.2K rpm LFF (3.5-inch) SC Midline 1yr Warranty Hard Drive	695510-B21
HP 3TB 6G SAS 7.2K rpm LFF (3.5-inch) SC Midline 1yr Warranty Hard Drive	652766-B21
HP 2TB 6G SAS 7.2K rpm LFF (3.5-inch) SC Midline 1yr Warranty Hard Drive	652757-B21
HP 1TB 6G SAS 7.2K rpm LFF (3.5-inch) SC Midline 1yr Warranty Hard Drive	652753-B21
HPE 4TB 12G SAS 7.2K rpm LFF (3.5-inch) SC Midline 1yr Warranty Hard Drive	818367-B21
HP 4TB 12G SAS 7.2K rpm LFF (3.5-inch) SC Midline 512e 1yr Warranty Hard Drive	765257-B21
HP 6TB 12G SAS 7.2K rpm LFF (3.5-inch) SC Midline 512e 1yr Warranty Hard Drive	765259-B21

Core Options

HP 6TB 12G SAS 7.2K rpm LFF (3.5-inch) SC 512e Performance 1yr Warranty Hard Drive 793671-B21

HP 4TB 12G SAS 7.2K rpm LFF (3.5-inch) SC 512e Performance 1yr Warranty Hard Drive 793669-B21

HPE 2TB 12G SAS 7.2K rpm LFF (3.5-inch) SC Midline 1yr Warranty Hard Drive 818365-B21

NOTE: User may select any combination of SAS or SATA Hard Drives. SAS drives require the selection of a SAS controller. See card lists in Controllers section.

If B140i is the primary controller, user can only select SATA drives.

SATA Hot Plug SFF (2.5-inch) Midline (MDL) Drives

HP 1TB 6G SATA 7.2K rpm SFF (2.5-inch) SC Midline 1yr Warranty Hard Drive 655710-B21

HP 500GB 6G SATA 7.2K rpm SFF (2.5-inch) SC Midline 1yr Warranty Hard Drive 655708-B21

HP 1TB 6G SATA 7.2K rpm SFF (2.5-inch) SC 512e 1yr Warranty Hard Drive 765453-B21

HP 2TB 6G SATA 7.2K rpm SFF (2.5-inch) SC 512e 1yr Warranty Hard Drive 765455-B21

NOTE: User may select any combination of SAS or SATA Hard Drives. SAS drives require the selection of a SAS controller. See card lists in Controllers section.

If B140i is the primary controller, user can only select SATA drives.

SATA Hot Plug LFF (3.5-inch) Midline (MDL) Drives

HP 6TB 6G SATA 7.2K rpm LFF (3.5-inch) SC Midline 1yr Warranty Hard Drive 753874-B21

HP 4TB 6G SATA 7.2K rpm LFF (3.5-inch) SC Midline 1yr Warranty Hard Drive 693687-B21

HP 3TB 6G SATA 7.2K rpm LFF (3.5-inch) SC Midline 1yr Warranty Hard Drive 628061-B21

HP 2TB 6G SATA 7.2K rpm LFF (3.5-inch) SC Midline 1yr Warranty Hard Drive 658079-B21

HP 1TB 6G SATA 7.2K rpm LFF (3.5-inch) SC Midline 1yr Warranty Hard Drive 657750-B21

HP 500GB 6G SATA 7.2K rpm LFF (3.5-inch) SC Midline 1yr Warranty Hard Drive 658071-B21

HP 4TB 6G SATA 7.2K rpm LFF (3.5-inch) SC Midline 512e 1yr Warranty Hard Drive 765253-B21

HP 6TB 6G SATA 7.2K rpm LFF (3.5-inch) SC Midline 512e 1yr Warranty Hard Drive 765255-B21

HP 6TB 6G SATA 7.2K rpm LFF (3.5-inch) SC 512e Performance 1yr Warranty Hard Drive 793667-B21

HP 4TB 6G SATA 7.2K rpm LFF (3.5-inch) SC 512e Performance 1yr Warranty Hard Drives 793665-B21

HP 6TB 6G SATA 7.2K rpm LFF (3.5-inch) SC 512e Helium 1yr Warranty Hard Drive 793683-B21

HP 8TB 6G SATA 7.2K rpm LFF (3.5-inch) SC 512e Helium 1yr Warranty Hard Drive 793695-B21

NOTE: User may select any combination of SAS or SATA Hard Drives.

If B140i is the primary controller, user can only select SATA drives. SAS drives require the selection of a SAS controller. See card lists in Controllers section.

6G SATA SC Hot Plug LFF 7.2K (3.5-inch) Standard Drives

HPE 1TB 6G SATA 7.2K rpm LFF (3.5in) SC Standard 1yr Warranty Hard Drive 858594-B21

HPE 2TB 6G SATA 7.2K rpm LFF (3.5in) SC Standard 1yr Warranty Hard Drive 858596-B21

6G SATA Hot Plug SFF Value Endurance (2.5-inch) Enterprise Value M1 Solid State Drives

Core Options

HP 120GB 6G SATA Value Endurance SFF 2.5-in SC Enterprise Value 3yr Wty M1 Solid State Drive 764923-B21

6G SATA Hot Plug MU-3 SFF (2.5-inch) SC Solid State Drives

HP 480GB 6G SATA Read Intensive-3 SFF 2.5-in SC 3yr Wty Solid State Drive 816899-B21

HP 240GB 6G SATA Read Intensive-3 SFF 2.5-in SC 3yr Wty Solid State Drive 816889-B21

6G SATA Hot Plug LFF (3.5-inch) MU-3 SCC SSD

HP 960GB 6G SATA Mixed Use-3 SFF 2.5-in SC 3yr Wty Solid State Drive 816995-B21

HP 480GB 6G SATA Mixed Use-3 SFF 2.5-in SC 3yr Wty Solid State Drive 816985-B21

HP 240GB 6G SATA Mixed Use-3 SFF 2.5-in SC 3yr Wty Solid State Drive 816975-B21

Hard Drive Kits

HPE ML30 Gen9 8 Small Form Factor Hot Plug Hard Drive Cage Kit 822756-B21

HPE ML30 Gen9 4 Large Form Factor Hot Plug Hard Drive Cage Kit 822608-B21

HP Large Form Factor Hard Drive Blank Kit 666986-B21

HP Small Form Factor Hard Drive Blank Kit 666987-B21

HP ML10v2 Drive Enablement Kit 812248-B21

NOTE: Compatible with all chassis and supports NHP LFF Hard Disk. If ATX PSU is installed, system support up to 2x. If RPS is installed, system support up to 1x.

HPE Networking

1 Gigabit Ethernet adapters

HP Ethernet 1Gb 4-port 331T Adapter 647594-B21

HP Ethernet 1Gb 2-port 361T Adapter 652497-B21

HP Ethernet 1Gb 2-port 332T Adapter 615732-B21

10 Gigabit Ethernet adapters

HP Ethernet 10Gb 2-port 560SFP+ Adapter 665249-B21

HP Ethernet 10Gb 2-port 557SFP+ Adapter 788995-B21

HP Ethernet 10Gb 2-port 530T Adapter 656596-B21

HP Ethernet 10Gb 2-port 530SFP Adapter 652503-B21

HP Ethernet 10Gb 2-port 561T Adapter 716591-B21

NOTE: Max=1 if selected with another x8 device.

HPE Power Supplies

HPE Entry-Level Power Supplies

HPE ML30 Gen9 350W E-star 1.0 FIO Power Supply Kit 820303-B21

NOTE: Max=1

NOTE: The HPE ML30 Gen9 350W E-star 1.0 FIO Power Supply Kit supports Bronze-level efficiency (no less than 82%) at all load

HPE ML30 Gen9 350W E-star 2.0 Power Supply Kit 822384-B21

NOTE: Max=1

NOTE: The HPE ML30 Gen9 350W E-star 2.0 Power Supply Kit supports Silver-level efficiency (no less than 85%) at all load

HP 460W CS Gold Ht Plg Power Supply Kit 503296-B21

NOTE: Must select 4U RPS Enablement Kit.

Max=2

Customer can select:

Core Options

460W Hot Plug Power Supply x1 + 4U RPS Enablement Kit x1

460W Hot Plug Power Supply x2 + 4U RPS Enablement Kit x1

HPE ML30 Gen9 4U Redundant Power Supply Enablement Kit

822607-B21

NOTE: Required for 460W Hot Plug Power Supply.

Max=1

**HPE Computation
and Graphics
Accelerators**

HP NVIDIA Quadro K2200 Graphics Accelerator

J0G89A

NOTE: A x16 device cannot be selected together with GPU.

**HPE Cooling
Options**

HPE ML30 Gen9 Front PCI Redundant Fan Kit

820290-B21

Additional Options

NOTE: Some options may not be integrated at the factory. To ensure only valid configurations are ordered, Hewlett Packard Enterprise recommends the use of an HPE approved configurator. Contact your local sales representative for additional information.

HPE Insight Software	HPE Insight Control	
	HPE Insight Control including 1yr 24x7 TSU E-LTU	C6N28ABE
	HPE Insight Control including 1yr 24x7 Technical Support and Updates 1-server LTU	C6N27A
	HPE Insight Management Media Kit	C6N31A
	HPE Insight Control including 1yr 24x7 Support ProLiant ML/DL/BL-bundle Single Server FIO LTU	C6N36A
	HPE Insight Control including 1yr 24x7 Support ProLiant ML/DL/BL-bundle FIO E-LTU	C6N36ABE

NOTE: Electronic and Flexible-Quantity licenses can be used to purchase multiple licenses with a single activation key.

NOTE: Customer will receive a license entitlement certificate. The license entitlement certificate must be redeemed online or via fax in order to obtain the license activation key(s). Includes one year of 24 x 7 HPE Software Technical Support and Update Service.

NOTE: Licenses ship without media. The HPE Insight Control Media Kit can be ordered separately, or can be downloaded at: <http://www.hp.com/go/insightupdates>.

NOTE: For additional license options please see the **HPE Insight Control QuickSpecs**.

Embedded Management	HPE iLO Advanced	
	HPE iLO Advanced including 3yr 24x7 Technical Support and Updates E-LTU	E6U64ABE
	HPE iLO Advanced including 1yr 24x7 Technical Support and Updates 1-server LTU	512485-B21
	HPE iLO Advanced including 3yr 24x7 Tech Support and Updates 1-server LTU	BD505A
	HPE iLO Advanced including 3yr 24x7 Tech Support and Updates Flexible Quantity LTU	BD506A
	HPE iLO Advanced including 3yr 24x7 Tech Support and Updates Tracking LTU	BD507A
	HPE iLO Advanced including 1yr 24x7 Technical Support and Updates E-LTU	E6U59ABE
	HPE iLO Essentials	
	HPE iLO Essentials including 3yr 24x7 Tech Support and Updates 1-server LTU	BD774A
	HPE iLO Essentials including 1yr 24x7 Tech Support and Updates 1-server LTU	BD775A
	HPE iLO Essentials including 3yr 24x7 Technical Support and Updates E-LTU	E6U61ABE
	HPE iLO Essentials including 1yr 24x7 Technical Support and Updates E-LTU	E6U62ABE

NOTE: For additional license kits, including electronic delivery options, please see the **HPE Integrated Lights-Out (iLO) QuickSpecs**.

NOTE: For more information, visit: <http://www.hp.com/go/ilo>.

HPE Security	HP Trusted Platform Module 2.0 Kit	745823-B21
	NOTE: HPE Trusted Platform Module 2.0 Option works with Gen9 servers with UEFI Mode not Legacy Mode. It is not compatible with HPE ProLiant Gen8 servers or earlier generation variants.	
	NOTE: HPE Gen9 servers purchased earlier may need the latest firmware update to be compatible with the TPM 2.0 Option.	

Additional Options

NOTE: HPE server systems can have a TPM module (of any type) installed only once. It cannot be replaced with any other TPM module.

HPE Storage Controllers

SAS Controllers

HP Smart Array P440/2GB FBWC 12Gb 1-port Int SAS Controller 820834-B21

NOTE: Device Count - This controller can support up to 8 internal SAS/SATA devices

Must select P440/P840 Cable Kit x1

Max=1

Must select Megacell battery x1 + battery holder kit x1 if no other P-series controllers are selected.

HP Smart Array P440/4GB FBWC 12Gb 1-port Int SAS Controller 726821-B21

NOTE: Device Count - This controller can support up to 8 internal SAS/SATA devices

Must select P440/P840 Cable Kit x1

Must select Megacell battery x1 + battery holder kit x1 if no other P-series controllers are selected.

Max=1

HP Smart Array P441/4GB FBWC 12Gb 2-ports Ext SAS Controller 726825-B21

NOTE: Must select Megacell battery x1 + battery holder kit x1 if no other P-series controllers are selected.

Max=1

HP ML110 Gen9 Mini SAS P440/P840 Cable Kit 789651-B21

NOTE: 1pcs required per P440/4G or P440/2G controller.

SAS Controller Options

HP 96W Smart Storage Battery with 145mm Cable for DL/ML/SL Servers 727258-B21

NOTE: Max=1.

Battery Holder

HP ML150 Gen9 Smart Storage Battery Holder Kit 786710-B21

NOTE: Max=1.

HPE Smart Host Bus Adapters

HP H240 12Gb 2-ports Int Smart Host Bus Adapter 726907-B21

NOTE: Device Count - This controller can support up to 8 internal SAS/SATA devices

1pc required per H240 controller for HPE 4LFF Mod-X

2pcs required per H240 controller for 8SFF Mod-X

Max=1

HP H241 12Gb 2-ports Ext Smart Host Bus Adapter 726911-B21

NOTE: Max=1

HP ML110 Gen9 Mini SAS H240 Cable Kit 789648-B21

NOTE: 1pc required per H240 controller for HPE 4LFF Mod-X.

NOTE: 2pcs required per H240 controller for 8SFF Mod-X.

HPE Tape Backup

NOTE: For the complete range of tape drives, autoloaders, libraries and media see: <http://www.hp.com/go/tape>. For hardware and software compatibility of HPE tape backup products see: <http://www.hp.com/storage/SPOCK> and <http://www.hp.com/go/ebs>.

Additional Options

NOTE: Must select SAS controller to support internal SAS tape drives.

NOTE: Tape drive and HDD total amount can't exceed SAS controller support qty.

NOTE: Limited to H240 when select Tape Drive.

Tape Drives

HPE StoreEver LTO-7 Ultrium 15000 External Tape Drive	BB874A
HPE StoreEver LTO-6 Ultrium 6650 SAS External Tape Drive	EH964A
HPE StoreEver LTO-6 Ultrium 6650 SAS Internal Tape Drive	EH963A
HPE StoreEver LTO-6 Ultrium 6250 External Tape Drive	EH970A
HPE StoreEver LTO-6 Ultrium 6250 Internal Tape Drive	EH969A
HPE StoreEver LTO-5 Ultrium 3280 SAS External Tape Drive	EH900B
HPE StoreEver LTO-5 Ultrium 3000 SAS External Tape Drive	EH958B
HPE StoreEver LTO-4 Ultrium 1760 SAS External Tape Drive	EH920B
HPE StoreEver LTO-3 Ultrium 920 SAS External Tape Drive	EH848B
HPE StoreEver Mini-SAS High Density to 4-lane Mini-SAS External Fanout 2m Cable	K2R09A
HPE StoreEver Mini-SAS High Density to 4-lane Mini-SAS External Fanout 4m Cable	K2R10A
HPE ML30 Gen9 Tape Drive Cable Kit	851615-B21

NOTE: Required per RDX/LTO internal disk backup system if selected together with 350W ES1.0 or ES2.0 power supply.

NOTE: HPE ML30 Gen9 server requires HPE ML30 Gen9 Tape Drive Cable Kit (851615-B21) for internal tape drive support.

SAS Rack-Mount Tape Solutions

HPE StoreEver 1U SAS Rack Mount Kit	AE459B
HPE StoreEver LTO-6 Ultrium 6250 Tape Drive in a 1U Rack Mount Kit	COL99A
HPE StoreEver LTO-4 Ultrium 1760 SAS (1) in a 1U Rack Mount Kit	EH946C
HPE StoreEver LTO-5 Ultrium 3000 SAS Tape Drive in a 1U Rack Mount Kit	EJ014B

HPE MSL2024 Tape Library

HPE StoreEver MSL2024 0-drive Tape Library	AK379A
--	--------

HPE MSL4048 Tape Library

HPE StoreEver MSL4048 0-drive Tape Library	AK381A
--	--------

HPE 1/8 G2 Tape Autoloader

HPE StoreEver 1/8 G2 LTO-6 Ultrium 6250 Fibre Channel Tape Autoloader	COH19A
---	--------

HPE StoreEver MSL6480

HPE StoreEver MSL6480 Scalable Base Module	QU625A
HPE StoreEver MSL6480 Scaleable Expansion Module	QU626A

HPE Disk Backup HPE RDX Removable Disk Backup System

HP RDX1000 USB3.0 Internal Disk Backup System	B7B67A
HP RDX500 USB3.0 Internal Disk Backup System	B7B64A
HP RDX USB 3.0 Internal Docking Station	C8S06A
HP D3700 Enclosure	QW967A
HP D3600 Enclosure	QW968A
HP RDX 2TB USB3.0 Internal Disk Backup System	E7X52A

NOTE: HPE ML30 Gen9 server requires HPE ML30 Gen9 Tape Drive Cable Kit (851615-B21) for internal tape drive support.

Additional Options

HPE StoreOnce Backup systems

HPE StoreOnce 5100 48TB System	BB915A
HP StoreOnce 4700 24TB Backup	BB879A
HP StoreOnce 4500 24TB Backup	BB878A
HPE StoreOnce 3540 24TB System	BB914A
HPE StoreOnce 3520 12TB System	BB922A
HPE StoreOnce 3100 8TB System	BB913A

HPE Disk Storage Systems

Disk Enclosures

HP D6000 Dual I/O Module Disk Enclosure	QQ695A
NOTE: See the HPE D6000 Disk Enclosure QuickSpecs for additional information including configuration steps and additional options needed for a complete solution.	
HP D6000 w/35 4TB 6G SAS 7.2K LFF Dual Port MDL HDD 140TB Bundle	E7W30A
HP D6000 w/70 4TB 6G SAS 7.2K LFF Dual Port MDL HDD 280TB Bundle	E7W31A
HP D6000 w/35 2TB 6G SAS 7.2K LFF Dual port MDL HDD 70TB Bundle	QQ697A
HP D6000 w/70 2TB 6G SAS 7.2K LFF Dual port MDL HDD 140TB Bundle	QQ698A
HP D6000 w/35 3TB 6G SAS 7.2K LFF Dual port MDL HDD 105TB Bundle	QQ699A
HP D6000 w/70 3TB 6G SAS 7.2K LFF Dual port MDL HDD 210TB Bundle	QQ700A
HP D2600 w/12 4TB 6G SAS 7.2K LFF Dual Port MDL HDD 48TB Bundle	E7W32A
HP D6000 w/70 6TB 12G SAS 7.2K LFF (3.5in) Dual Port MDL HDD 420TB Bundle	MOT57A
HP D6000 w/35 8TB 12G SAS 7.2K LFF (3.5in) Dual Port MDL HDD 280TB Bundle	MOT58A
HP D6000 w/70 8TB 12G SAS 7.2K LFF (3.5in) Dual Port MDL HDD 560TB Bundle	MOT59A

HPE USB and SD Options

HPE Enterprise Mainstream Flash Media Kits for Memory Cards

HP 8GB microSD Enterprise Mainstream Flash Media Kit	726116-B21
HP 32GB microSD Enterprise Mainstream Flash Media Kit	700139-B21
HP 8GB USB Enterprise Mainstream Flash Media Drive Key Kit	737953-B21
HP Dual 8GB microSD Enterprise Midline USB Kit	741279-B21

HPE Support Services

Installation & Start-up Services

HPE Installation ML/DL Series 10 Service	U7WZ5E
HPE Startup ML/DL Series 10 Service	U7WZ7E

Foundation Care

HPE 3 year Foundation Care Next business day ML30 Gen9 Service	H1AS0E
HPE 3 year Foundation Care Next business day with DMR ML30 Gen9 Service	H1AS1E
HPE 3 year Foundation Care 24x7 ML30 Gen9 Service	H1AS6E
HPE 3 year Foundation Care 24x7 with DMR ML30 Gen9 Service	H1AS7E
HPE 3 year Foundation Care Next business day with CDMR ML30 Gen9 Service	H1AX4E
HPE 3 year Foundation Care 24x7 with CDMR ML30 Gen9 Service	H1AX7E

Proactive Care

HPE 3 year Proactive Care 24x7 ML30 Gen9 Service	H1AS8E
HPE 3 year Proactive Care 24x7 with DMR ML30 Gen9 Service	H1AS9E

Additional Options

HPE 3 year Proactive Care 24x7 with CDMR ML30 Gen9 Service

H1AX8E

NOTE: For a full list of available support services, please visit <https://ssc.hpe.com/portal/site/ssc/>

Memory

NOTE: Memory configurations listed do not apply to "Factory Integrated Models".

HPE Standard Memory

HPE Standard Memory is unique technology which is designed to work on 10/100 series Rack and Tower server. In Gen9 Server HPE Standard Memory has passed HPE's rigorous qualification and test processes. HPE Standard Memory is a certified HPE options and will provide a platform to allow future memory-related support enhancements through HPE Active Health System, System Insight Management and Insight Control management software.

DDR4 memory population guidelines

For detailed memory configuration rules and guidelines, please use the Online DDR4 Memory Configuration Tool: <http://www.hp.com/go/ddr4memory-configurator>.

Memory Population guidelines

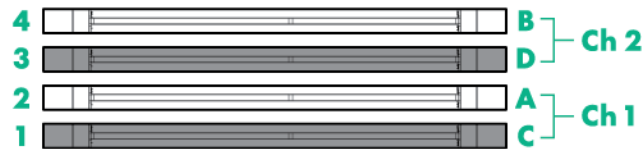

General Memory Population Rules and Guidelines:

- . The HPE ProLiant ML30 Gen9 Server has four memory slots
- . There are two channels per server with two DIMM slots per channel
- . Memory channel 1 consists of the two (2) DIMMs that are closest to the processor
- . Memory channel 2 consists of the two (2) DIMMs that are furthest from the processor
- . Support for single/dual-rank 2133 MT/s ECC UDIMM (unbuffered DIMMS)
- . The server supports up to 64 GB (4 x 16-GB) for Unbuffered DIMMs
- . No support for LRDIMMs; RDIMMs; Non-ECC UDIMMs
- . Do not install DIMMs if the processor is not installed
- . Populate DIMMs from heaviest load (double-rank) to lightest load (single-rank)
- . Non-ECC DIMMs are not supported
- . Always use HPE qualified DIMMs

Intel Gen9 Supported Memory Bandwidth for HPE ProLiant Gen9 Intel® Xeon® E3-1200v5 Series Processor Family

Memory Bandwidth and Capacity				
[DIMM Type]	Unbuffered with ECC DIMMs (UDIMMs)			
HPE SKU P/N	805667-B21	819880-B21	805669-B21	805671-B21
DIMM Rank	Single Rank	Single Rank	Dual Rank	Dual Rank
DIMM Capacity	4GB	8GB	8GB	16GB

Memory

Voltage	Std Voltage 1.2V	Std Voltage 1.2V	Std Voltage 1.2V	Std Voltage 1.2V
DIMM Native Speed (MT/s)	2133	2133	2133	2133
SLOTS THAT CAN BE POPULATED				
4 slot servers	4	4	4	4
MAXIMUM CAPACITY (GB)				
	16	32	32	64
POPULATED DIMM SPEED (MT/s)				
1 DIMM Per Channel	2133	2133	2133	2133
2 DIMM Per Channel	2133	2133	2133	2133
3 DIMM Per Channel				

DIMM slot and configuration diagram

Standard memory replaced with optional memory (1 CPU model)

- Population order; start with "A" first, "B" second, "C" third, etc.
- Population order; start with "A" first, "B" second, "C" third, etc.
- When two processors are installed, install DIMMs in sequential alphabetic order: CPU1-A, CPU2-A, CPU1-B, CPU2-B, CPU1-C, CPU2-C

		CPU 1		CPU 2	
		Slot #	population order	Slot #	population order
Chnl 1	1		C	1	
	2		A	2	
		CPU 1		CPU 2	
		Slot #	population order	Slot #	population order
Chnl 2	3		D	3	
	4		B	4	

Memory Speed by Processor Model

Processor Models	Supported Memory Speeds
G4400, G4500, i3-6300, i3-6100, E3-1220v5, E3-1230v5, E3-1240Lv5, E3-1240v5, E3-1270v5	2133MT/s

Standard and Maximum Memory Capacity (Pre-configured Models)

Pre Configured Models	Standard Memory	Maximum Memory Plus Optional Memory	Standard Memory Replaced with Optional Memory
E3-1220v5	4GB (1x4GB)	52GB (3x16GB, 1x4GB)	64GB (4x16GB)
E3-1240v5	8GB (1x8GB)	56GB (3x16GB, 1x8GB)	64GB (4x16GB)

Memory

DDR4 memory options part number decoder

NOTE: Capacity references are rounded to the common gigabyte (GB) values.

- 2GB = 2,048MB
- 4GB = 4,096MB
- 8GB = 8,192MB
- 16GB = 16,384MB
- 32GB = 32,768MB
- 64GB = 65,536MB

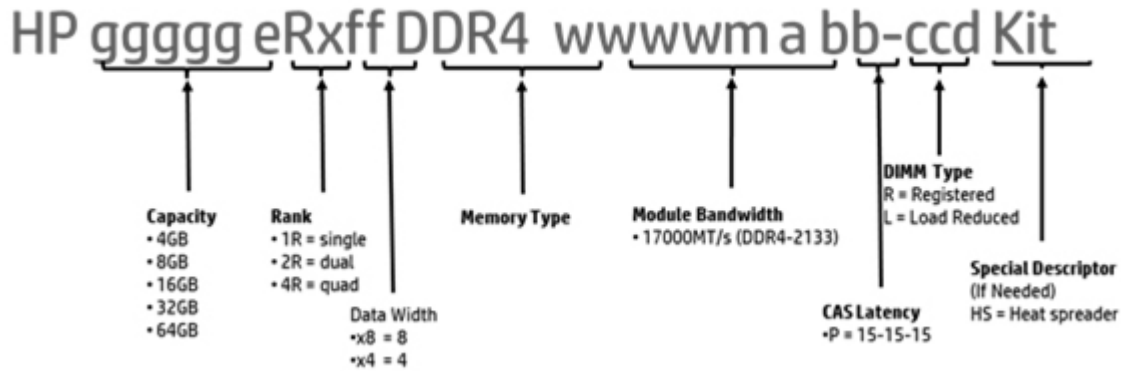

Storage

4-Bay LFF non-hot-plug drive model

1-4

4 x LFF SATA/SSD Non-hot-plug Hard Drive Bays

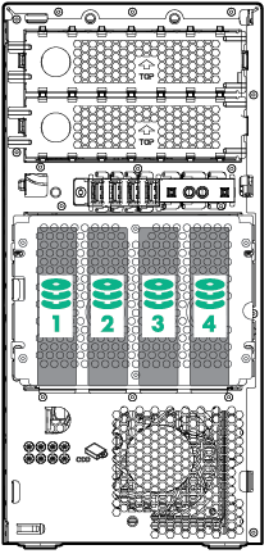

4-bay LFF hot-plug drive model

1-4

4 x LFF SAS/SSD Hot Pluggable Hard Drive Bays

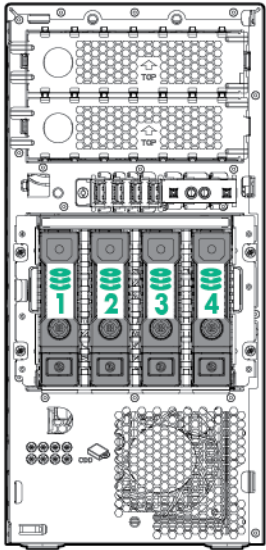

8-bay SFF hot-plug drive model

1 x 8

8 x SFF SATA/SSD Hot Pluggable Hard Drive Bays

Storage

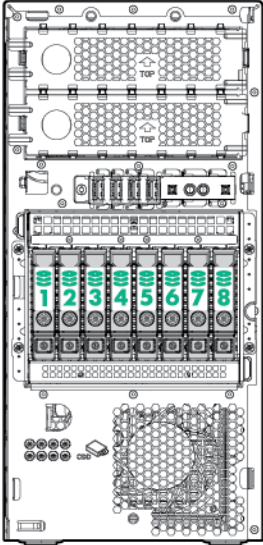

Maximum Storage Capacity -

Total (4 LFF Drive) 32TB

Total (8 SFF Drive) 16TB

Technical Specifications

System Unit	Tower Dimensions	14.50(H) x 6.89(W) x 18.7(D) in (36.82 x 17.5 x 47.52 cm)	
	Tower Weight	Minimum: 27.1lb(13.56kg) Maximum: 30.8lb(15.4kg)	
	Input Requirements	Range Line Voltage	100 to 120 VAC
		Rated Input Current	2.5 to 6 Amps
		Rated Input Frequency	47 to 63 Hz
		Rated Input Power	412W to 526W at 115 V AC input 412W to 523W at 230 V AC input
		BTU Rating	Maximum 460W - 1773 BTU / hr (at 120 VAC), 1715 (at 240 VAC)
	Power Supply Output	Rated Steady-State Power	350 W (at 115 VAC) 350 W (at 230 VAC)
		Maximum Peak Power	350 W (at 115 VAC) 350 W (at 230 VAC)
		System Inlet Temperature	Standard 10° to 35°C (50° to 95°F) at sea level with an altitude derating of 1.0°C per every 304.8 m (1.8°F per every 1000 ft) above sea level to a maximum of 3048 m (10,000 ft), no direct sustained sunlight. Maximum rate of change is 10°C/hr (18°F/hr). The upper limit may be limited by the type and number of options installed. System performance may be reduced if operating with a fan fault or above 30°C (86°F). Operating Support Non-operating -30° to 60°C (-22° to 140°F). Maximum rate of change is 20°C/hr (36°F/hr).
	Relative Humidity	Operating	10 to 90% relative humidity (Rh), 28°C (82.4°F) maximum wet bulb temperature.
		Non-operating	5 to 95% relative humidity (Rh), 38.7°C (101.7°F) maximum wet bulb temperature, noncondensing.
	Altitude	Operating	3048 m (10,000 ft). This value may be limited by the type and number of options installed. Maximum allowable altitude change rate is 457 m/min (1500 ft/min).
		Non-operating	9144 m (30,000 ft). Maximum allowable altitude change rate is 457 m/min (1500 ft/min).
	Acoustic Noise	Listed are the declared A-Weighted sound power levels (LWAd) and declared average bystander position A-Weighted sound pressure levels (LpAm) when the product is operating in a 23°C ambient environment. Noise emissions were measured in accordance with ISO 7779 (ECMA 74) and declared in accordance with ISO 9296 (ECMA 109).	
		Idle	
		L WAd	4.2 Bels (1P LFF Base) 3.7 Bels (1P LFF Performance)
		L pAm	27 dBA (1P LFF Base) 23 dBA (1P LFF Performance)
		Operating	
		L WAd	4.2 Bels (1P LFF Base)

Technical Specifications

	3.8 Bels (1P LFF Performance)
L pAm	27 dBA (1P LFF Base)
	23 dBA (1P LFF Performance)

NOTE: Configurations tested for 1P LFF Base models include one (1) 1TB LFF SATA Midline HDD and Windows 2012 Enterprise 64-bit.

NOTE: Configurations tested for 1P LFF Performance models include one (1) 1TB LFF SATA Midline HDD and Windows 2012 Enterprise 64-bit.

NOTE: The Listed sound levels apply to standard shipping configurations. Additional options may result in increased sound levels.

NOTE: Levels presented do not account for non-Hewlett Packard Enterprise installed hardware.

Emissions Classification	FCC Rating	Class B
	Normative Standards	CISPR 22; EN55022; EN55024; FCC CFR 47, Pt 15; ICES-003; CNS13438; GB9254; K22;K24; EN 61000-3-2; EN 61000-3-3; EN 60950-1; IEC 60950-1

NOTE: Product conformance to cited product specifications is based on sample (type) testing, evaluation, or assessment. This product or family of products is eligible to bear the appropriate compliance logos and statements.

HPE Dynamic Smart Array B140i Controller	Number of PCI links	Four
	PCI link rate	4 Gb/s
	Storage protocol support	SATA
	SAS/SATA peak data transfer rate	6 Gb/s
	Number of SAS/SATA links	10 links
	SAS/SATA connectivity	2x4 connectors; 2x1 connectors
	Expander support	No
	Drives supported (max)	Up to 10 Internal Drives
	RAID support	0, 1, 10, 5 SATA
	Software management	HPE SSA, SMH, SIM
	Warranty	Server warranty
	HPE Secure Encryption license	Not Supported
	HPE SmartCache License	Not Supported

Technical Specifications

HPE Smart Storage Administrator Supported

HPE Ethernet 1Gb 2-port 332i Adapter	Network Interface	10Base-T/100Base-TX/1000Base-TX	
	Compatibility	IEEE 802.3 10Base-T IEEE 802.3ab 1000Base-T IEEE 802.3u 100Base-TX	
	Data Transfer Method	PCI Express, two lanes (x2)	
	Controller	BCM5720	
	Network Transfer Rate	10Base-T (Half-Duplex)	10 Mb/s per port, 40 Mb/s combined
		10Base-T (Full-Duplex)	20 Mb/s per port, 80 Mb/s combined
		100Base-TX (Half-Duplex)	100 Mb/s per port, 400 Mb/s combined
		100Base-TX (Full-Duplex)	200 Mb/s per port, 800 Mb/s combined
		1000Base-TX (Half-Duplex)	1000Mb/s per port, 4000 Mb/s combined
		1000Base-TX (Full-Duplex)	2000Mb/s per port, 8000 Mb/s combined
Connector	RJ-45		
Cable Support	10 Base-T	Categories 3, 4 or 5 UTP; up to 328 ft (100 m)	
	10/100/1000 Base-TX	Category 5 or higher UTP; up to 328 ft (100 m)	

Environment-friendly Products and Approach	End-of-life Management and Recycling	Hewlett-Packard offers end-of-life Hewlett Packard Enterprise product return, trade-in, and recycling programs in many geographic areas. For trade-in information, please go to: http://www.hp.com/go/green . To recycle your product, please go to: http://www.hp.com/go/green or contact your nearest Hewlett Packard Enterprise sales office. Products returned to Hewlett Packard Enterprise will be recycled, recovered or disposed of in a responsible manner.
---	---	--

The EU WEEE directive (2002/95/EC) requires manufacturers to provide treatment information for each product type for use by treatment facilities. This information (product disassembly instructions) is posted on the Hewlett Packard Enterprise web site at: <http://www.hp.com/go/green>. These instructions may be used by recyclers and other WEEE treatment facilities as well as Hewlett Packard Enterprise OEM customers who integrate and re-sell Hewlett Packard Enterprise equipment.

Summary of Changes

Date	Version History	Action	Description of Change
6-Jun-2016	From Version 5 to 6	Added	Added new HDD offering to the HPE Drives section.
8-Apr-2016	From Version 4 to 5	Changed	HPE Processors section was revised.
31-Mar-2016	From Version 3 to 4	Added	Added new HPE TMP 2.0 module, and new RDX Disk Backup Systems.
		Changed	Embedded Management, Security, Service and Support, and Pre-configured Models sections were revised.
		Removed	Obsolete SKUs were removed from the QuickSpecs.
16-Feb-2016	From Version 2 to 3	Added	New HDD offering was added to HPE Drives.
		Changed	HPE Unique Options and HPE Tape Backup were revised.
		Removed	Obsolete SKUs were removed from the QuickSpecs.
17-Dec-2015	From Version 1 to 2	Added	Smart Buy models were added to the NA version.
		Changed	Chipset, Pre-Configure Models, HPE Drives, HPE Power Supplies, HPE Tape Backup, Maximum Storage Capacity, and Technical Specifications were revised.



Sign up for updates

© Copyright 2016 Hewlett Packard Enterprise Development LP. The information contained herein is subject to change without notice. The only warranties for Hewlett Packard Enterprise products and services are set forth in the express warranty statements accompanying such products and services. Nothing herein should be construed as constituting an additional warranty. Hewlett Packard Enterprise shall not be liable for technical or editorial errors or omissions contained herein.

Intel® and Xeon® are registered trademarks of Intel Corporation in the U.S. and other countries.

Microsoft®, Windows®, and Windows Server® are U.S. registered trademarks of the Microsoft group of companies.

For hard drives, 1GB = 1 billion bytes. Actual formatted capacity is less

c04834991 - 15475 - Worldwide - V6 - 6-June-2016

